



PyroFlex Package Burner

PyroFlex 2000

Parameter		Specifications
Maximum Input, Btu/hr (kW) ¹	Integral Blower	2,000,000 (528)
	External Blower	3,700,000 (976)
Low Firing Rate, Btu/hr (kW) ¹		40,000 (11)
Natural Gas Pressure at Burner Head, "w.c. (mbar) ²		1.5 (4)
Air Pressure at Burner Head, "w.c. (mbar)	Low Pressure Model	2 (5)
	High Pressure Model	6 (15)
	External Blower	20 (50)
Blower Motor, HP (kW) ³	Low Pressure Model	0.75 (0.55)
	High Pressure Model	2.0 (1.5)
	External Blower ⁴	10 (7.5)
Flame Length, inches (mm)	Low Pressure Model	50 (1270)
	High Pressure Model	46 (1168)
	External Blower	58 (1473)
Maximum Temperature, F° (C°)	Alloy Discharge Sleeve	1200 (649)
	SiC Discharge Sleeve	1800 (982)
Ignition Type		Direct Spark or Pilot
Flame Detection		Flame Rod or UV Scanner
Fuels		Low Btu Gases to Butane
Conformance		 

All imperial inputs based on gross calorific values (HHV). All metric inputs based on net calorific values (LHV).

- Maximum, low fire, and pilot inputs are given for the standard, integral air blowers at 1,000 ft elevation. Higher elevations may require a larger capacity blower.
- Values are given for integral blower arrangement at high fire, under neutral pressure chamber conditions and with 30% excess air through burner. Pyroflex is available in two models of combustion fan, low pressure and high pressure.
- Blower motors are TEFC and in most instances compatible for 50 or 60 hz. Operating at 50 hz will reduce impeller speed and burner capacity by 17% and combustion air maximum pressures listed above by 31%.
- Motor size will depend on capacity, external blower selection and piping resistance (between fan and burner). Motor size indicated in the above table assumes 3,700,000 Btu/hr, 45% static fan efficiency and 3" w.c. of additional air piping loss.

NOTE: All values are approximate. To check if packages meet other agency requirements, contact the factory. Standard configurations are for indoor application. Specify outdoor use and NEMA or IP rating required for optional configuration.

NOTICE: Selas practices a policy of continuous improvement in the design of its products. It reserves the right to change the specifications at any time without prior notice.



The Heat Technology Company™

PyroFlex Model Numbers

Selas utilizes an intelligent part numbering system for all PyroFlex models. Please use the below key to see available burner options.

Example P/N: PF750N-HFB-AFD-XX

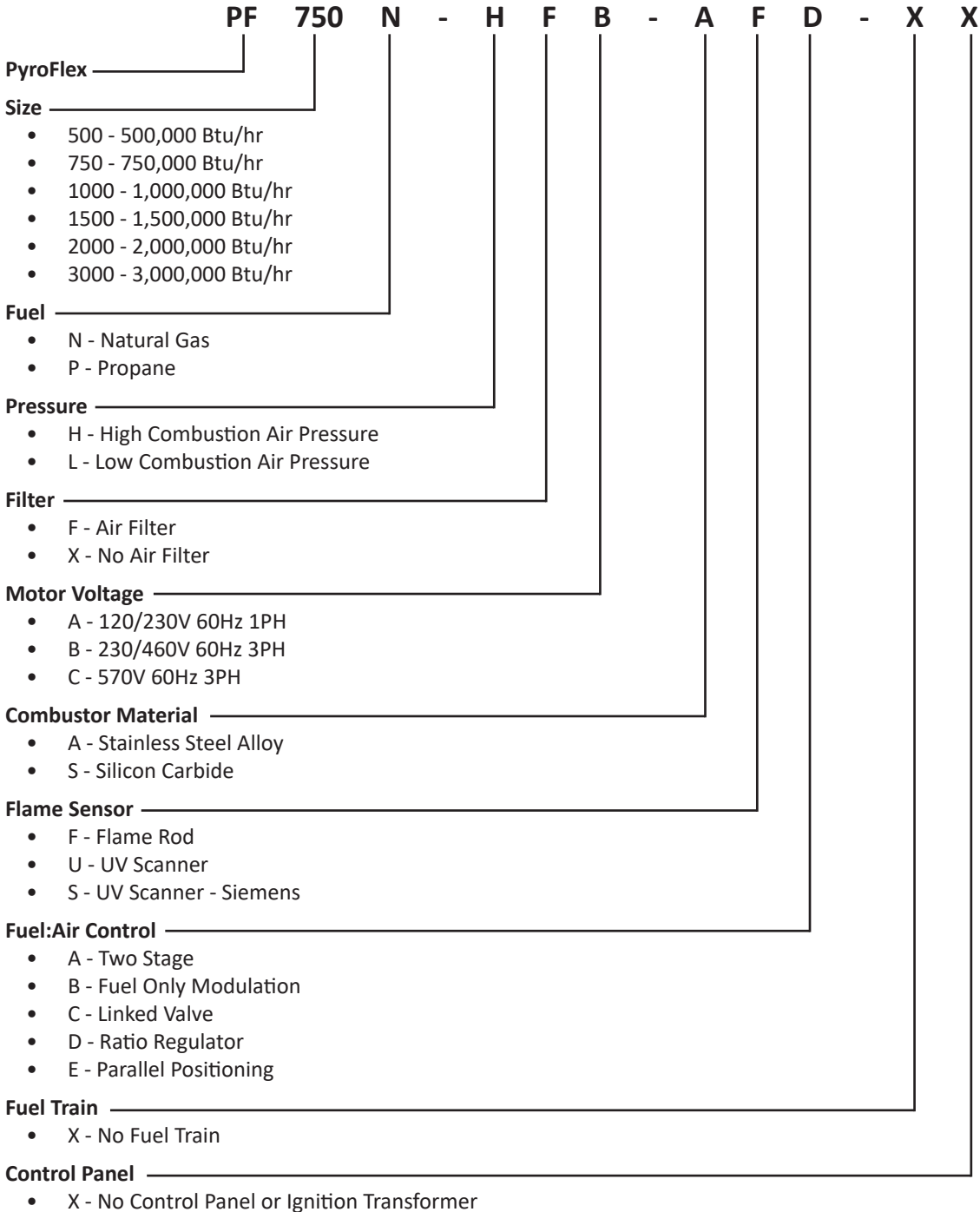

Options and Control Configurations

Consult Selas for custom packaging options.

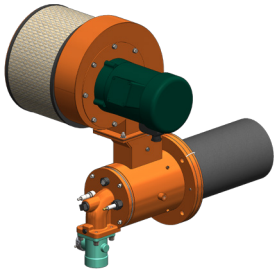

On-Off Control

- Manual Adjust Fuel Balancing Valve
- Manual Adjust Air Damper
- Low or High Pressure Blower with TEFC Motor and Pressure Switch
- Blower Filter (recommended)
- 310 Alloy or SiC Discharge Sleeve
- Flame Rod (supplied with burner) or UV (sold separate)

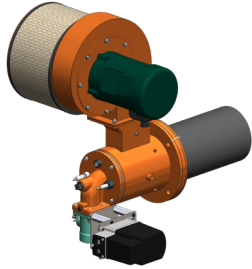

Fixed Air - Fuel Only Control

- Fuel Valve with Actuator
- Manual Adjust Air Damper
- Low or High Pressure Blower with TEFC Motor and Pressure Switch
- Blower Filter (recommended)
- 310 Alloy or SiC Discharge Sleeve
- Flame Rod (supplied with burner) or UV (sold separate)

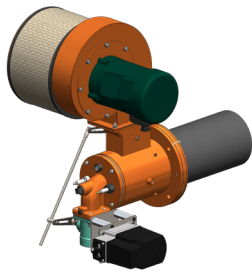

Linked Valve Control

- Fuel Valve with Actuator Linked to Air Damper
- Low or High Pressure Blower with TEFC Motor and Pressure Switch
- Blower Filter (recommended)
- 310 Alloy or SiC Discharge Sleeve
- Flame Rod (supplied with burner) or UV (sold separate)

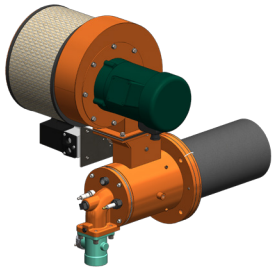

Impulse Ratio-Regulator Control

- Air Damper with Actuator
- Impulse Connection to Ratio Regulator
- Manual Adjust Fuel Balancing Valve
- Low or High Pressure Blower with TEFC Motor and Pressure Switch
- Blower Filter (recommended)
- 310 Alloy or SiC Discharge Sleeve
- Flame Rod (supplied with burner) or UV (sold separate)

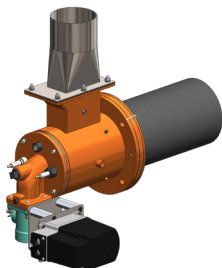

External Blower

- Fuel Valve with Actuator
- Manual Adjust Air Damper
- Blower and Air Supply Piping by Customer
- 310 Alloy or SiC Discharge Sleeve
- Flame Rod (supplied with burner) or UV (sold separate)



Close up view of the manual control knob



The Heat Technology Company™

PyroFlex Package Burner

Base Dimensions

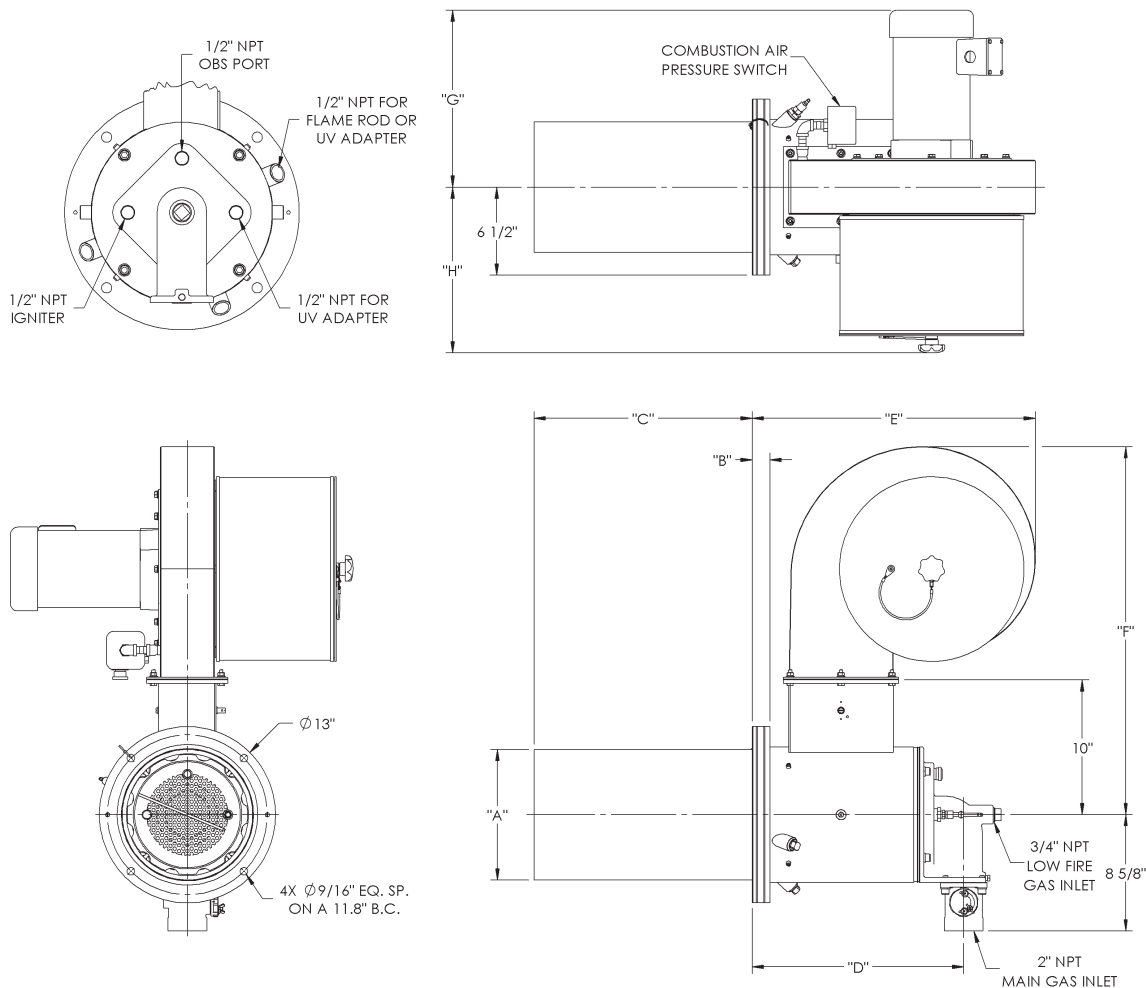

PyroFlex 2000 Base Burner Configuration		A	B	C	D	E	F	G	H	Weight
Low Pressure Blower	Alloy Discharge Sleeve	9-1/4	3/4	15-1/2	15-1/2	16-1/2	22-7/8	11-1/4	10-1/4	131
	SiC Discharge Sleeve	9-5/8	1-3/8	16-1/8	15-5/8	17	22-7/8	11-1/4	10-1/4	145
High Pressure Blower	Alloy Discharge Sleeve	9-1/4	3/4	15-1/2	15-1/2	20-3/8	27-1/8	13	12-1/4	152
	SiC Discharge Sleeve	9-5/8	1-3/8	16-1/8	15-5/8	20-7/8	27-18	13	12-1/4	166

NOTES:

- All dimensions are in inches +/- 1/8. G dimension approximate, depending on motor manufacturer. Dimensions subject to change without notice. Weight is in pounds and represents base burner, blower and discharge sleeve.
- Does not include accessories.
- Igniter, UV adapter and observation port are interchangeable on gas connection. Flame rod connection at burner flange.
- Burner may be mounted in other configurations. Good practice dictates that the blower motor shaft remain horizontal.

11012 Aurora Hudson Rd • Streetsboro, OH 44241

1-800-523-6500 • sales@selas.com

www.selas.com



The Heat Technology Company™